

Article number: 05904118

Description: Hepco cap seal CS 18

## Measures

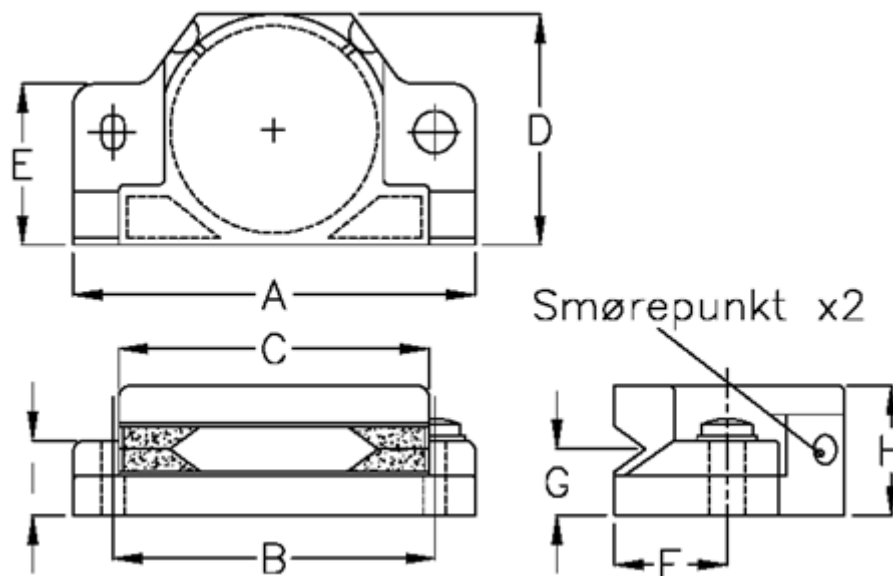

A = 42

B = 32.5

C = 32.3

D = 21.2

E = 18

F = 12.3

G = 6.75

H = 13.8

I = 6.0

Weight kg/1000 = 0.006